

AgieCharmilles

CUT 2000 S

CUT 3000 S



Becoming better every day – since 1802

GF Machining Solutions

When all you need is everything, it's good to know that there is one company that you can count on to deliver complete solutions and services. From unmatched Electrical Discharge Machining (EDM), Laser texturing, Laser micromachining, Additive Manufacturing and first-class Milling and Spindles to Tooling and Automation, all of our solutions are backed by unrivaled customer service and expert GF Machining Solutions training. Our AgieCharmilles, Microlution, Mikron Mill, Liechti, Step-Tec and System 3R technologies help you raise your game—and our digital business solutions for intelligent manufacturing, offering embedded expertise and optimized production processes across all industries, increase your competitive edge.



+ We are AgieCharmilles.
We are GF Machining Solutions.

Contents

4	Highlights
6	Mechanics
8	Automatic wire changer (AWC)
9	Wire guidance
10	CNC Vision 5
11	Digital LPG generator
12	IVU Advance
14	Autonomy and Automation
15	Technical specifications
18	GF Machining Solutions

CUT 2000 S and CUT 3000 S

Increase speed thanks to the new Direct Power supply module, meet the challenges of miniaturization and machine with high precision, the CUT 2000 S and CUT 3000 S are designed to maximize productivity.

Highlights

High precision and unequaled productivity



High-level generator to increase speed

Thanks to the new Direct Power Supply module adapted to the Intelligent Power Generator (IPG), machining times are reduced by more than 30 percent.

Meeting the challenges of miniaturization

More and more, tools require the use of wires of very fine diameters. The CUT 2000 S and CUT 3000 S have been designed to meet this challenge. They machine with wires as small as 0.05 mm (0.002 in) in diameter.

A reputation for very high precision

The machining precision is the result of a set of technical choices, such as the mechanical concept, the machining process, and wire guidance. Each element of the CUT 2000 S and CUT 3000 S has been thought through and implemented in the smallest details, with the sole objective of ensuring high precision for the entire lifetime of the machine.

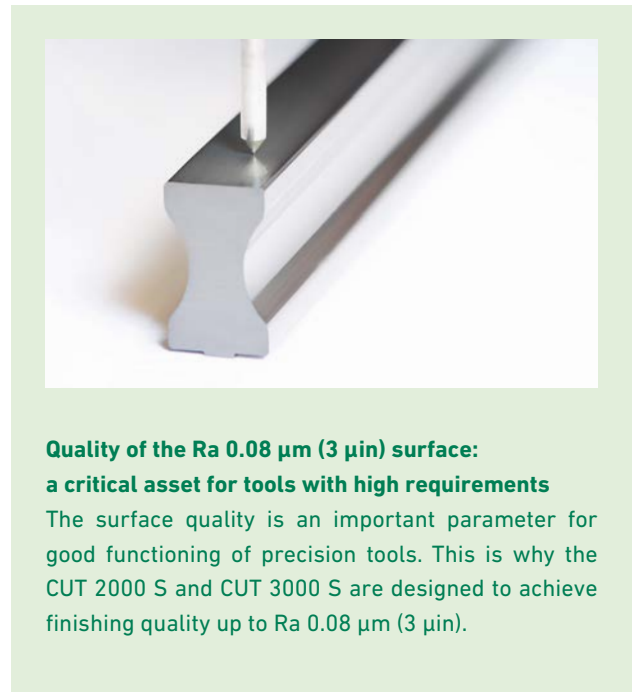

Quality of the Ra 0.08 µm (3 µin) surface: a critical asset for tools with high requirements

The surface quality is an important parameter for good functioning of precision tools. This is why the CUT 2000 S and CUT 3000 S are designed to achieve finishing quality up to Ra 0.08 µm (3 µin).



+ Two wires to double productivity

The third-generation automatic wire changer gives the CUT 2000 S and the CUT 3000 S versatile, ease of use, and unequalled productivity. Each user, according to his needs and his imagination, will improve the profitability of his equipment by using one or more of the exclusive possibilities offered by two wire circuits.

Mechanics

A concept dedicated to high precision



The mechanical structure is adapted to the requirements for very high precision

Thanks to the concept of the crossed table situated directly under the piece to be machined, the high precision guides and high-precision glass scales are situated as close as possible to the machining zone. This choice contributes to maximizing precision and repeatability of positioning. The play in inversion is almost eliminated.

Thermal stability

All components of the machine that dissipate heat are cooled by water circulation, so the EDM generator and all pumps have their own cooling systems. All equipment is thus preserved against parasitic heat sources induced by the machine. This thermal stability contributes to guaranteeing the very high precision expected of this machine.

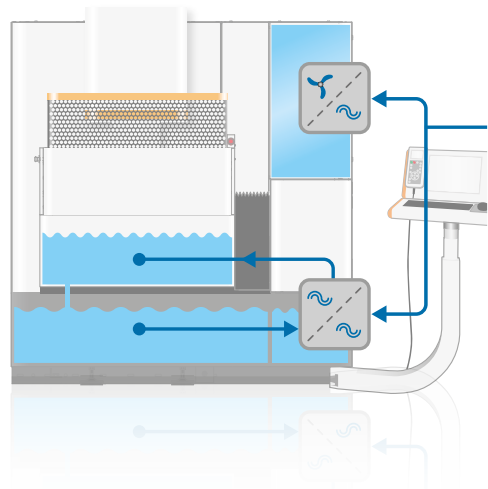

Swiss production

The ultra-modern assembly line meets the criteria for Swiss quality. Each individually calibrated machine is delivered with a certificate of quality attesting to its conformity with the requirements of all GF Machining Solutions machines. The measurement and regulating data are stored in the machine and can be consulted or called up at any time.





The compact structure reduces the machine footprint on floor space

Floor space is an important issue in workshops. The concept of the CUT 2000 S and CUT 3000 S take this imperative into account. They are remarkably economical in terms of floor space consumed, through both the dimensions of the machine and the need for accessibility for maintenance.

Ergonomics and comfort in service of performance

The retractable trough gives remarkable access and a view of the entire work zone. This ease of operation in preparing for machining contributes to achieving the objective of high quality delivered by the CUT 2000 S and the CUT 3000 S. Ongoing maintenance is facilitated by easy access to the filtering layers in front of the machine and the wire magazine. Dead times are reduced to the minimum.

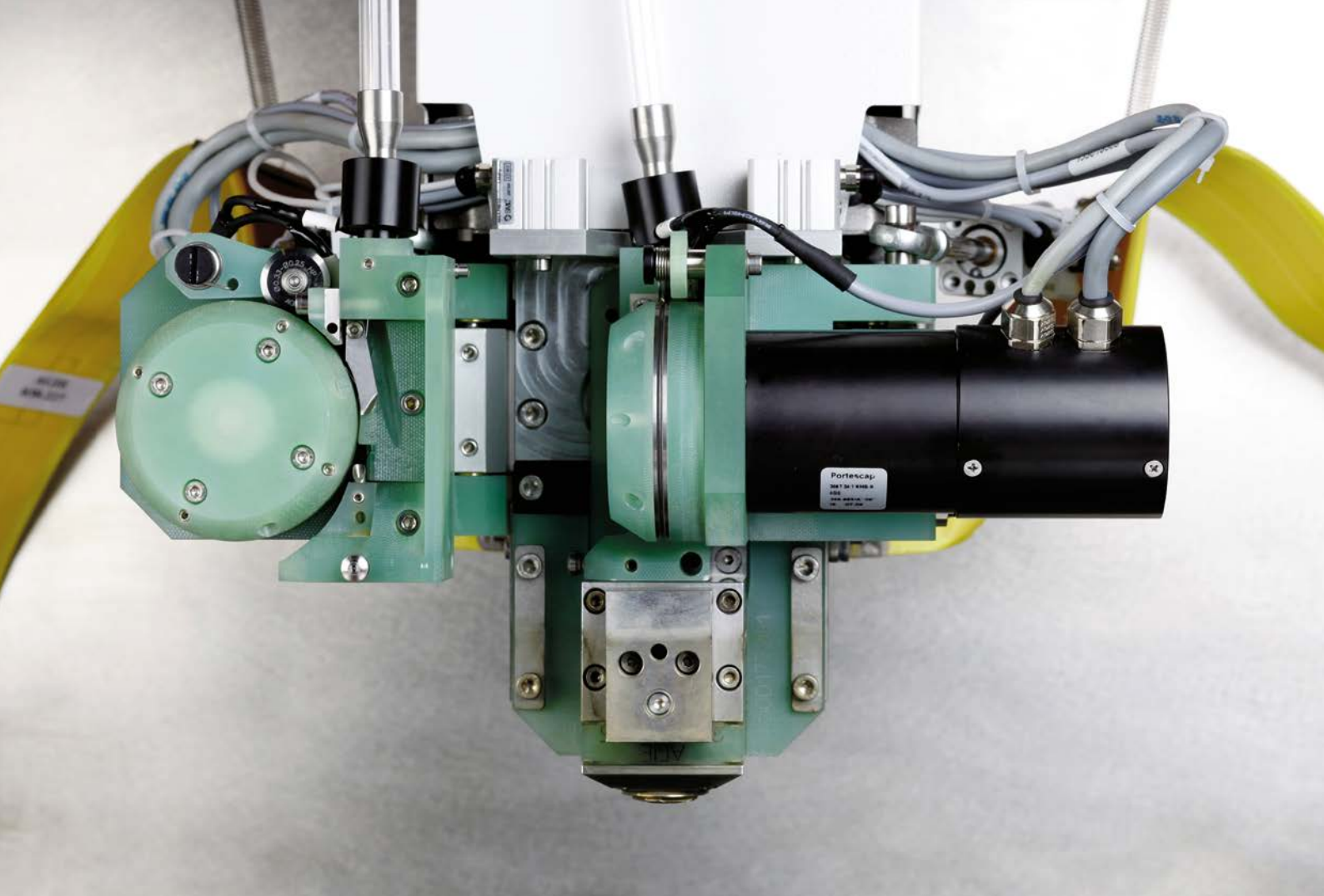

Automatic wire changer (AWC)

AWC boosts your productivity, thanks to wire optimization

AWC for fast machining with thin wires

GF Machining Solutions' groundbreaking AWC automatically changes wire diameters during machining. The AWC is unique on the market. With AWC, it is possible to make the first cut with a big wire, and automatically change to a small wire (0.05, 0.07, 0.1) to save machining time. As a result, you can cut a part with small wire at a speed similar to cutting with a big wire.

Wire quality optimization

Depending on the target, changing the wire during machining can be very challenging even without changing the diameter. Often, a special and expensive wire is only necessary for finishing cuts (surface quality) or for roughing cuts (speed optimization). To reduce wire costs, a less expensive wire can be used for one or more of the cuts, depending on the customer's objectives.

Small details in large heights

Cut heights greater than 40 mm with a thin wire are unprofitable and often require changes to the original shape as the cutting speed is too low. The AWC is the solution for the machining of fine details in tall parts.

Save wire costs by using small wire only for finishing

Considering that the finishing speed is the same regardless of the wire diameter, using a small wire for finishing cuts must be considered, regardless of the contour. The unspooling speed is the same for finishing cuts and the machining speed is similar; consequently, the lighter weight, small wire is needed for the same machining length.

Wire guidance

An exclusive, precise, and polyvalent system

THREADING-EXPERT

Threading under even the most difficult conditions

THREADING-EXPERT is a retractable device driving the wire from the upper guide to the start hole (upper surface) or directly to the lower guide (depending on the hole diameter) through a fine slotted tube.

Standard configuration with nozzle improving the reliability of threading whatever the wire-diameter (<0.3 mm) under standard conditions (close to the surface).

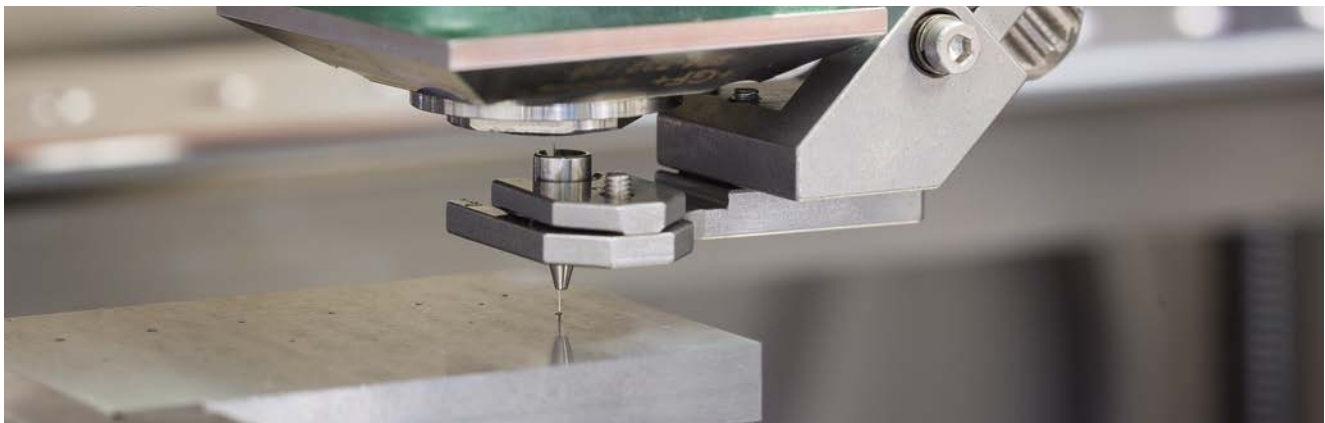

Great flexibility in the choice of wire diameter

One system of wire guides permits the use of all wire diameters from 0.05 to 0.30 mm (0.002 – 0.012 in). This exclusive CUT 2000 S/CUT 3000 S characteristic is not due to chance. The concept of all components involved in the movement of the wire is based on the long experience of GF Machining Solutions engineers in the service of high precision and flexibility of use. No additional cost is incurred when another wire diameter is necessary for manufacturing a new tool. Use of another wire diameter does not require any additional adjustment.

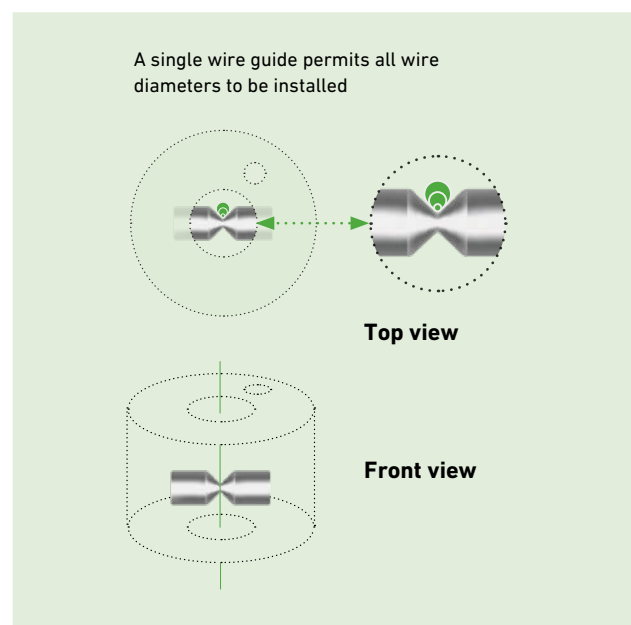

Power and efficiency of the Smart Modules

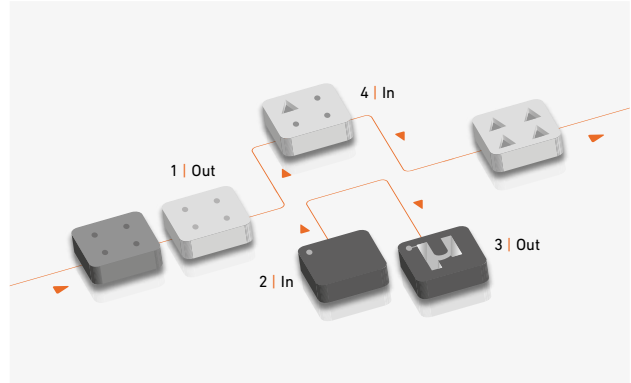
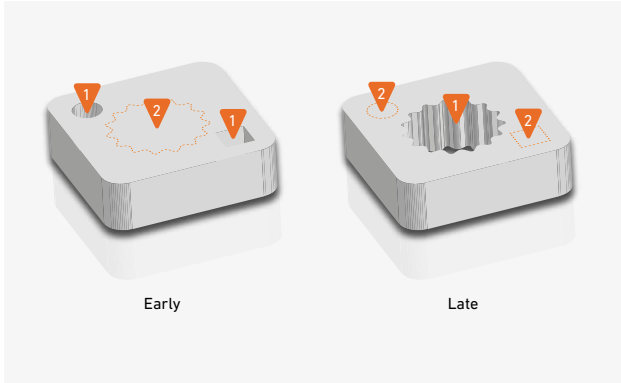

User sequence

Machining sequence can be modified at the last minute

It is sometimes difficult to respect the advance planning of the work envisioned for the day in the workshop. It can then be useful to modify the machining sequences, especially for managing the removal of waste at a time when personnel will be present. The CNC Vision 5 permits modification of each step in the machining order, regardless of the number of work holes in progress. The result: a significant increase in workshop productivity.

Job Management System

Face unexpected situations easily

It is very common to be confronted with a change in priorities in the flow of production in the workshops. Insertion of an urgent machining job into the work in progress can be done in a simple, rapid, and reliable manner. The Job Management system of the CNC Vision 5 provides a solution that permits suspension of the machining in progress in a simple and intuitive manner, insertion of the urgent work, and resumption of the previous work exactly at the place where it was before being interrupted.

AUTOFIX

Save processing time and labor costs

Easy to configure, AUTOFIX leaves a micro-fixture allowing to easily remove the core by a manual tap. Unlike the competitors' products, the result is a perfect surface quality after trim cuts with no material sediment on the part.

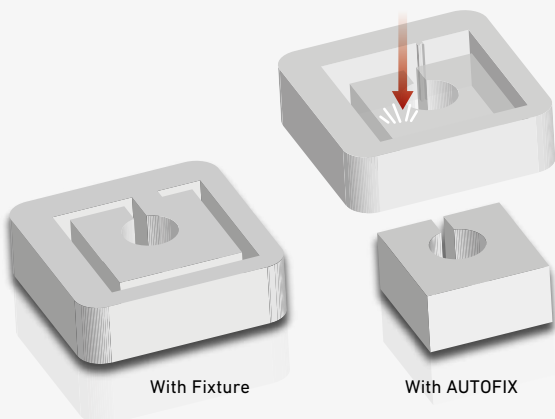

Comparison with standard rough cut (10 x 10 x 30 mm matrix)

10% time saving processing time (cut + manual operations) compared to traditional rough cut.

Multiple cavities plate (60 cavities/10 x 10 x 30 cavities)

Up to 97% less operator time for cut of fixture and slug removal.

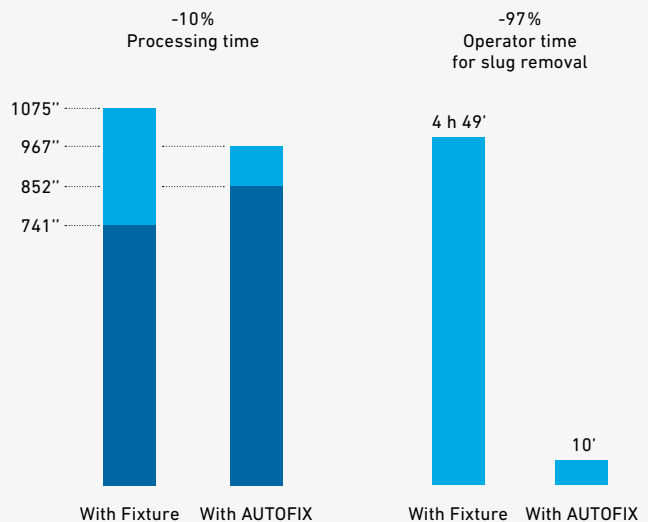

Digital IPG generator

Boost your machining speed

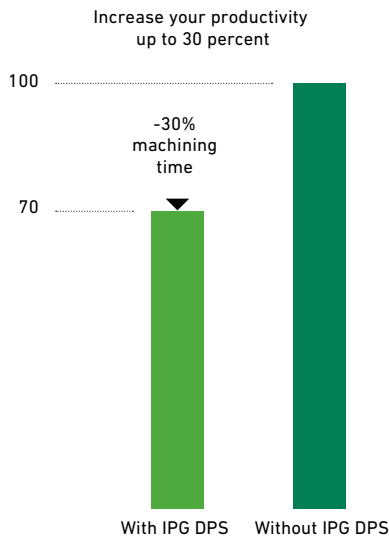

The new Intelligent Power Generation (IPG)

Direct Power Supply (DPS) generator

The CUT 2000 S and CUT 3000 S are aimed at demanding users with very different needs. In order to satisfy them, the new IPG generator with Direct Power supply module accommodates a very large range of machining systems, permitting a very high degree of precision associated with perfect surface quality and highest speed (30 percent vs. standard generator). This digital generator controls the energy of each spark with great precision, providing a very fine surface quality up to Ra 0.08 µm (3 µin).

Variocut and Smoothsurf

Optimal cutting speed, best surface uniformity

The high cutting speed is the basis of the productivity of the equipment. When the height of the piece varies, the Variocut system permanently optimizes the power of the spark.

The surface remains homogeneous and parallelism is constant. The Smoothsurf module is a step forward in surface uniformity, permitting the high level of regularity required in production of molds for plastic injection and powder compression. Polishing time is significantly reduced, and workshop productivity is increased.

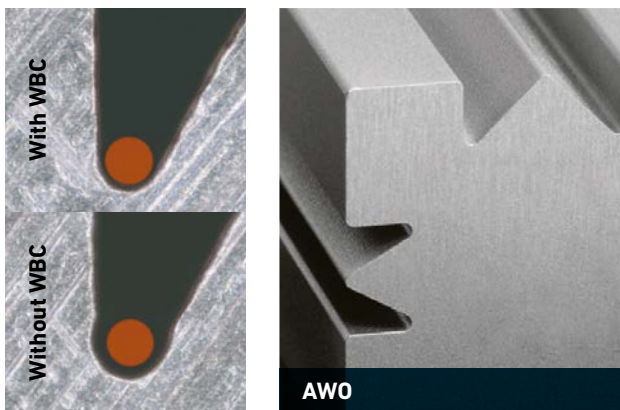
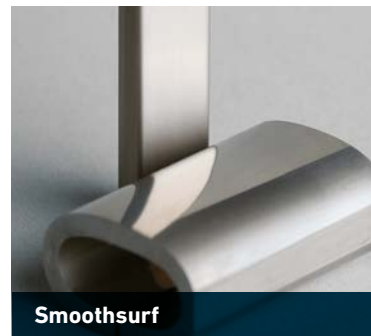

AWO and WBC functions

Perfect contour cuttings

In order to make a high-performance punching and stamping tool function with a play of a few microns, contour precision and perfect parallelism of the machined shapes must be assured. The CUT 2000 S and CUT 3000 S achieves exceptional performance thanks to automatic adjustment systems for the position and straightness of the wire. The Wire Bending Control (WBC) system compensates automatically for the bending of a wire subjected to spark forces, and the Advanced Wire Offset (AWO) functions compensate for the wear of the wire during finishing machining, for which parallelism of the surfaces thus machined is almost perfect.

IVU Advance

Easy, automatic, accurate measurement and positioning

Optical measurement system onboard

The new IVU Advance onboard the CUT 2000 S and CUT 3000 S allows detection without contact of the part's edges for realization of fully automatic measuring cycles and to measure piece dimensions pre-defined in the programming.

All this is done without removing the workpiece, thanks to an always ready to measure, charge-coupled device (CCD) camera with autofocus a perfect distance from the workpiece.

The contrast of the contour is enabled by the backlight installed on the lower arm of the machine.

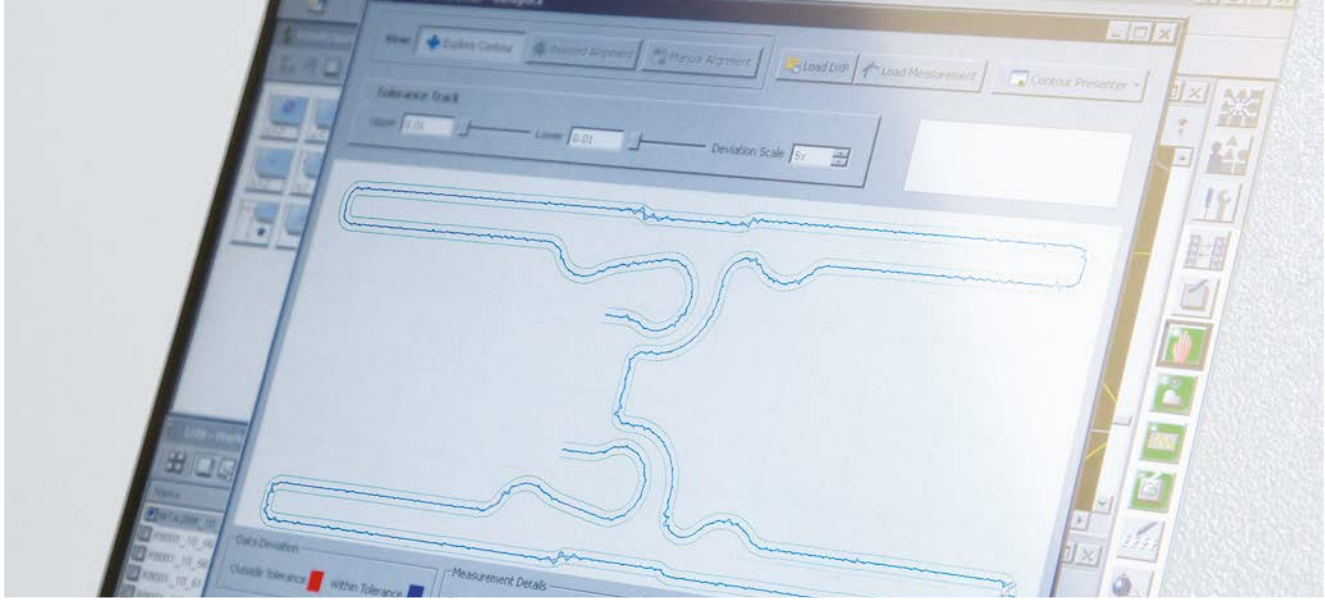

'Get the edge' concept

Special integrated software allows the machine to detect the right position of the edge by analyzing variations in light intensity. The resulting metrological data can be used in various applications. This functionality is the essential to get an accurate point $\pm 1\mu\text{m}$ with a magnification of 150X and $\pm 1.5\mu\text{m}$ with a magnification of 50X.

Take the reference and measuring cycles

The IVU Advance system makes it possible to take any reference on the workpiece for:

- hole centering
- corner detection
- internal or external centering between two faces
- distance between holes, centering, dimensions
- misalignment, etc.

All the cycles can be programmed and the reference (alignment, reference point or line) taken can be introduced in a job.

Local measurement

If some parts have some essential and accurate local details, it is always possible to take local measurements. Examples include radius, distance between lines, or the positioning of a special location on the workpiece.

Auto scanning of the form

A complete scan of the contour can be performed anytime. A comparison with a DXF file (theoretical size) can be done and visualized directly on the machine.

The measurement can come from a single image analysis or from a sequence of images acquired step by step from a contour automatically followed by the machine according to the analysis given by the camera.

The measurement can be done before the end of machining or as a final control step.

A contour correction will be proposed automatically by the machine in order to get 100 percent reliability of the machining result.

Auto scanning of multi-cavity parts

The scanning can be done not only on one form but also on a complete part including multiple shapes.

The comparison with the theoretical size can include more than one shape (according to the DXF used for basic programming).

This scanning can also be segmented to avoid any undesirable location on the contour.

Recognition of the position of X, Y, Z (fingerprint)

The IVU Advance enables to capture an image of the surface irregularities and the X, Y and Z coordinates. A comparison can be done later to measure any movement of the workpiece and the position can be corrected accordingly.

Correction of the path in case of deviation

Unique to the new version of the IVU Advance is the possibility to completely scan the contour and correct any difference between the theoretical size and the size measured on the same piece.

This makes it possible to ensure 100 percent reliability of the result and improvement of the process for each machining.



Autonomy and Automation

Equipment to maximize productivity

The CUT 2000 S and CUT 3000 S can be integrated effectively into an automated workshop. Autonomy of operation is assured with a 25 kg wire magazine and by a chopper to recover all used wire. [1]

Communication/supervision

The Vision 5 command permits a dialogue with a host computer. Integrated into a workshop with automated production, the machine can be controlled remotely and sent all information related to the machining process. [2]

Gain preparation time with Advanced Setup

Placement of the piece is an important operation that determines the final quality of the work. A permanent goal in all workshops is to reduce the time and cost dedicated to this operation. The Advanced Setup system is the solution, thanks to its automatic measurement that places the wire perpendicular to the surface of the piece to be machined. This operation is likewise possible automatically when the piece is palletized. [4]

Five controlled servo axes

The machine can be equipped with a rotating axle acting as a slave to the movement of the X, Y, U and V axes. This function permits execution of complex shapes that otherwise would be impossible. [3]

Automation for more productivity

With a retractable trough that frees space around the work zone, the CUT 2000 S and CUT 3000 S are the ideal machines to be equipped with an automatic pallet changer. The programmable dielectric level permits pieces of variable height to be installed, up to 250 mm (9.84 in) high. [5]



1



3



4

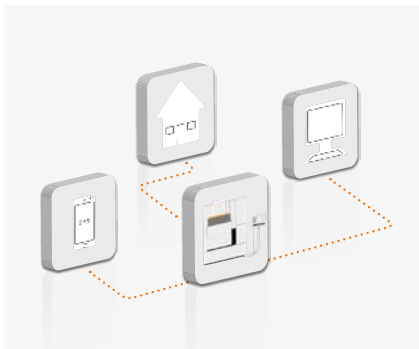

2



5

Technical specifications



CUT 2000 S



CUT 3000 S

		CUT 2000 S	CUT 3000 S
Wire guide			
Wire guides, standard equipment	∅ mm (in)	0.10–0.30 (0.004–0.012)	0.10–0.30 (0.004–0.012)
Wire guides (option)	∅ mm (in)	0.05–0.07 (0.002–0.003)	0.05–0.07 (0.002–0.003)
Automatic wire changer (AWC)		Option	Option
Threading Expert		Option	Option
Travels			
X, Y, Z axes	mm (in)	350 x 250 x 256 (13.77 x 9.84 x 10)	500 x 350 x 256 (19.7 x 13.77 x 10)
U, V axes	mm (in)	±70 (±2.7)	±70 (±2.7)
Max. taper angle	°/mm (°/in)	30/100 (30/3.93)	30/100 (30/3.93)
Max. speed X, Y	m/min.	3	3
Dual measuring system for X, Y		Standard	Standard
Workpiece			
Max. workpiece dimensions (*)	mm (in)	750 x 550 x 250 (29.5 x 21.6 x 9.8)	1050 x 650 x 250 (41.3 x 25.6 x 9.8)
Max. workpiece weight with bath/without bath	kg (lbs)	200 / 450 (440 / 992.08)	400 / 800 (880 / 1763.70)
Max. cutting rate with CCS ∅ 0.30 mm wire	mm ² /min. (in ² /h)	300 (28)	300 (28)
Surface finish	µm Ra (µin)	0.08 (3)	0.08 (3)
Threading system			
Threadable height	mm (in)	250 (9.84)	250 (9.84)
Threading nozzle	∅ mm / ∅ in	2 (0.6 option)/0.078 (0.023 option)	2 (0.6 option)/0.078 (0.023 option)
Combination wire guide system	"V" guide Toroid guide	Cylindrical–2° 2°–30°	Cylindrical–2° 2°–30°
Increased accuracy in tapered cut (CONIC PLUS)		Option	Option
Wire drive, wire spool	kg (lbs)	25 (55.11)	25 (55.11)
Wire disposal		Chopper	Chopper
Work area			
Accessibility		front / left / right	front / left / right
Universal clamping frame	mm (in)	700 x 450 (27.56 x 17.72)	850 x 550 (33.46 x 21.65)
Drop tank		Automatic	Automatic
Machining in bath, level regulation automatic	mm (in)	0–250 (0–9.84)	0–250 (0–9.84)
High power generator	~ A	IPG-V	IPG-V
Wide range of tested tech. for common users workpiece materials, technology modules		Standard	Standard
DCC (Dynamic Corner Control): Dynamic path optimisation and process adaptation in the radii		Standard	Standard
WBC (Wire Bending Control): Real time detection and correction of the wire bending		Standard	Standard
Real time detection of the workpiece cross section and automatic power optimisation (VARIOCUT)		Standard	Standard
Correction of the cylindrical residual error, AWO (Advanced Wire Offset)		Standard	Standard

* Width x depth x height

		CUT 2000 S	CUT 3000 S
Dielectric conditioning unit			
Dielectric conditioning unit integrated	l (us gal)	700 (180)	1000 (264)
Filter, 4 canisters with 8 cartridge filters		Standard	Standard
Filtrate quality	µm (µin)	5 (197)	5 (197)
Deionizing			
Resin (option)	l (us gal)	20 (5)	20 (5)
Cooling			
Generator and control unit with air / water, and dielectric with two water / water heat exchangers		Standard	Standard
System			
System dimensions (*)	mm (in)	2095 x 1950 x 2247 (83 x 77 x 89)	2685 x 2115 x 2247 (106 x 83 x 89)
Floor-to-clamping plane distance	mm (in)	1100 (43)	1100 (43)
Net weight	kg (lbs)	2800 (6200)	3800 (8400)
Weight ready-to-run	kg (lbs)	4500 (9920)	6000 (13200)
Control unit integrated, modules and functions			
Operator interface system		15"– LCD-display, keyboard and mouse	
Control unit integrated		VISION 5 (object oriented man-machine interface)	
Operating system		Multitasking Windows XP	
Operating mode		Multiprocessor	
Supplementary servocontrolled axis		A axis	
Smallest programmable step		0.0001 mm (0.000004 in)	
Easy preparation of machining programs		EASYWORK	
Pickup cycles for automatic determination of workpiece position		2D SETUP	
Pickup cycles for automatic determination of workpiece plane and position		3D SETUP (option)	
Automatic technology selection based on machining objectives		TECCUT	
Automatic optical measuring system		IVU Advance	
Import of job-specific data from CAD / CAM systems		CAMLINK	
Predefined machining strategies		AUTO SEQUENCE	
Predefined and user defined machining strategies		USER SEQUENCE	
Simple 2D on-board geometry programming and import of DXF and IGES files		GEOCONVERTER	
Quickly insert rush orders without effort		PIECE INSERT	
DNC port with Xon / Xoff and LSV2 protocols		DNC	
Help functions, explanations with text and graphics		HELP and online manual	
Machining simulation 2D and 3D view		GRAFICHECK	
Maximum safety through continuous data input		FORMALCHECK and data input Protocol	
Easy preparation of job templates		WORKMODEL	
Automatic machining sequence definition for multiple workpieces		LOTTO	
Rethreading on wire break/on "no- thread" detection restart after power failure		Rescue strategies	
Languages		English, CN, CZ, DE, DK, ES, FR, HU, IT, JP, NL, PL, RU, US, SE	
Storage capacity		> 20 GB HD, 512 MB Ram	
Interfaces		2x RS232C, 1x parallel, 1x LAN (Local Area Network), 1x USB	
Data storage media		CD/DVD-Rom for updates and online manual, floppy-disk, USB	
Interface for automation			
Basic equipment for handling devices		AUTOMATION KIT	
Communication interface for cell computer connection		HOSTCONTROL	
Connections			
Line power	kW	10.5	
Line voltage	V	3 x 400	
Compressed air		6 bar, 5 m ³ /h (85 psi, 6.54 yd ³ /h)	
Cooling capacity required	kW	1.5–7.5	

* Width x depth x height

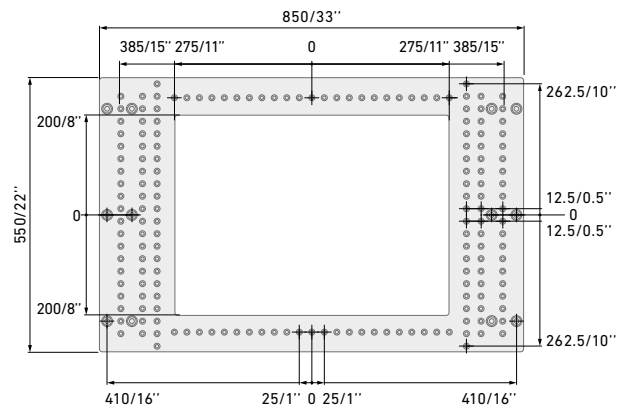
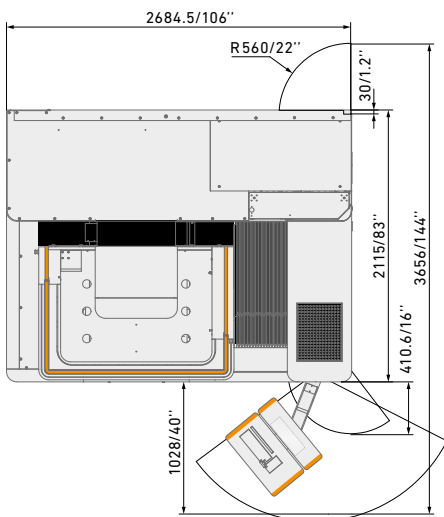
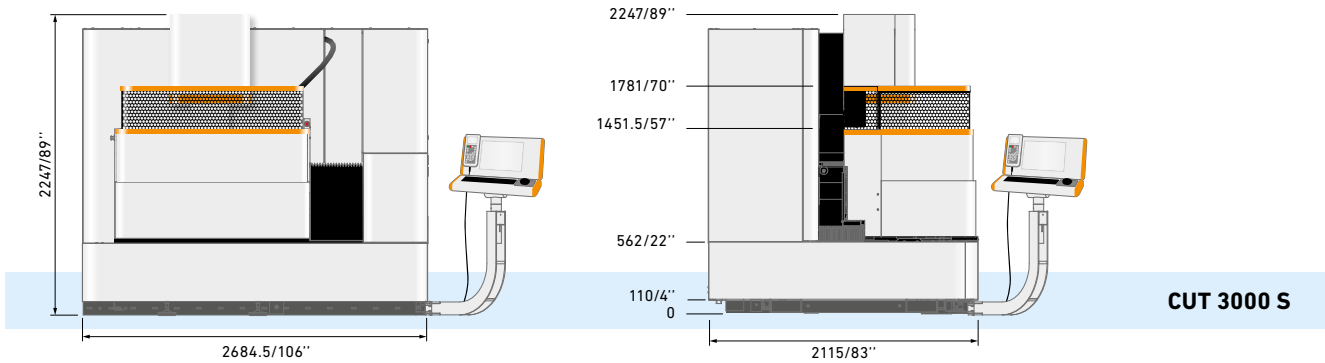
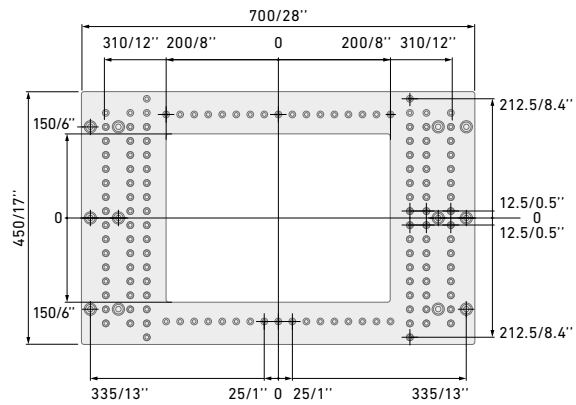
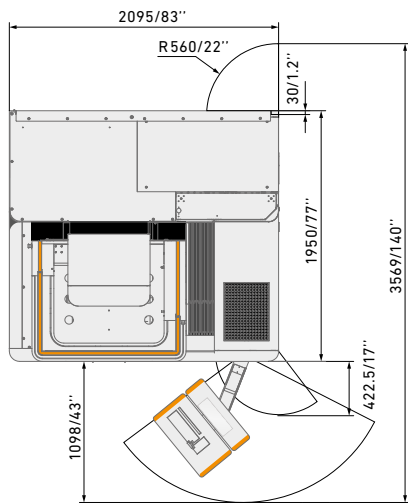
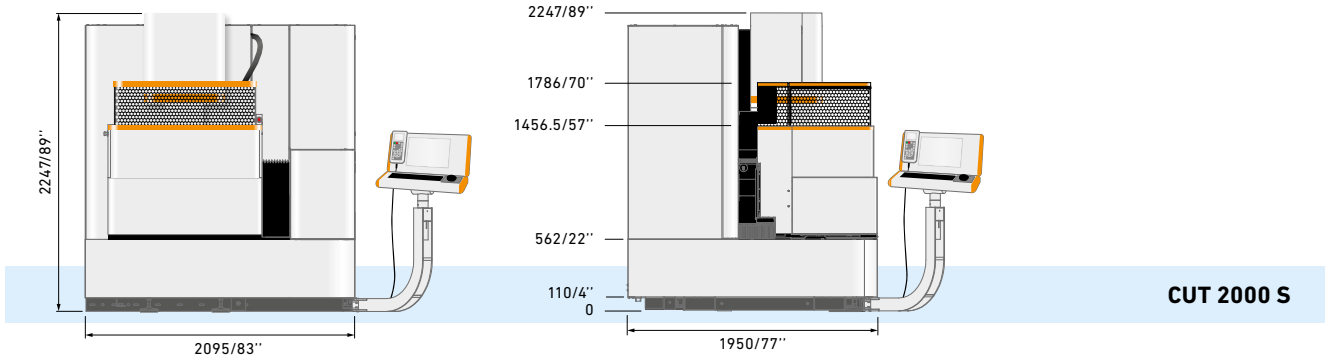

About GF Machining Solutions

Multi-technology solutions provider

Our commitment to you and your specific applications is proven by the value-adding intelligence, productivity and quality delivered by our multi-technology solutions. Your success is our chief motivator. That's why we are continuously advancing our legendary technical expertise. Wherever you are, whatever your market segment and whatever the size of your operation, we have the complete solutions and the customer-centric commitment to accelerate your success—today.

EDM (Electrical Discharge Machining)



Wire-cutting EDM

GF Machining Solutions' wire-cutting EDM is fast, precise and increasingly energy efficient. From ultraprecise machining of miniaturized components down to 0.02 mm to powerful solutions for demanding high-speed machining with respect to surface accuracy, our wire EDM solutions position you for success.

Die-sinking EDM

GF Machining Solutions is revolutionizing die-sinking EDM with features like iGAP technology to dramatically boost machining speed and reduce electrode wear. All of our die-sinking systems offer fast removal and deliver mirror finishes of Ra 0.1 µm (4 µin).

Hole-drilling EDM

GF Machining Solutions' robust hole-drilling EDM solutions enable you to drill holes in electrically conductive materials at a very high speed—and, with a five-axis configuration, at any angle on a workpiece with an inclined surface.

Tooling and Automation



Tooling

Our customers experience complete autonomy while maintaining extreme accuracy, thanks to our highly accurate System 3R reference systems for holding and positioning electrodes and work pieces. All types of machines can easily be linked, which reduces set-up times and enables a seamless transfer of workpieces between different operations.

Automation

Together with System 3R, we also provide scalable and cost-effective Automation solutions for simple, single machine cells or complex, multi-process cells, tailored to your needs.

Milling



Milling

Precision tool and mold manufacturers enjoy a competitive edge with our Mikron MILL S solutions' fast and precise machining. The Mikron MILL P machines achieve above-average productivity thanks to their high performance and Automation. Customers seeking fastest return on investment benefit from the affordable efficiency of our MILL E solutions.

High Performance Airfoil Machining

Our Liechti turnkey solutions enable the highly dynamic manufacturing of precision airfoils. Thanks to the unique performance and our expertise in airfoil machining, you increase productivity by producing at the lowest cost per part.

Spindles

As part of GF Machining Solutions, Step-Tec is engaged in the very first stage of each machining center development project. Compact design combined with excellent thermal and geometric repeatability ensure the perfect integration of this core component into the machine tool.

Software



Digitalization solutions

To drive its digital transformation, GF Machining Solutions acquired symmedia GmbH, a company specialized in software for machine connectivity. Together, we offer a complete range of Industry 4.0 solutions across all industries. The future requires the ability to adapt quickly to continual digital processes. Our intelligent manufacturing offers embedded expertise, optimized production processes, and workshop Automation: solutions for smart and connected machines.

Advanced manufacturing



Laser texturing

Aesthetic and functional texturing is easy and infinitely repeatable with our digitized Laser technology. Even complex 3D geometries, including precision parts, are textured, engraved, microstructured, marked and labeled.

Laser micromachining

GF Machining Solutions offers the industry's most complete line of Laser micromachining platforms optimized for small, high-precision features to meet the increasing need for smaller, smarter parts to support today's leading-edge products.

Laser Additive Manufacturing (AM)

GF Machining Solutions and 3D Systems, a leading global provider of additive manufacturing solutions and the pioneer of 3D printing, have partnered to introduce new metal 3D printing solutions that enable manufacturers to produce complex metal parts more efficiently.

Service + Success



We take you to new heights

Our Success Packs are designed to maximise your return on investment and empower you in your quest for success across all industrial segments. Our subscription packs feature a comprehensive range of services that guarantee the access and support you need to get the most out of your assets today, while preparing for the challenges of tomorrow. Our trusted experts backed by our latest cutting-edge, intelligent Digital Solutions, provide a full range of services.



Switzerland

Biel/Bienne
Losone
Geneva
Flawil
Langnau

www.gfms.com
www.gfms.com/ch

Europe

Germany, Schorndorf
www.gfms.com/de

United Kingdom, Coventry
www.gfms.com/uk

Italy, Agrate Brianza - MI
www.gfms.com/it

Spain, Sant Boi de Llobregat
Barcelona
www.gfms.com/es

France, Palaiseau
www.gfms.com/fr

Poland, Raszyn / Warsaw
www.gfms.com/pl

Czech Republic, Brno
www.gfms.com/cz

Sweden, Vällingby
www.gfms.com/system3r

Turkey, Istanbul
www.gfms.com/tr

Americas

USA
Lincolnshire, IL
Chicago, IL
Holliston, MA
Huntersville, NC
Irvine, CA
Woodridge, IL
www.gfms.com/us

Canada, Mississauga ON
www.gfms.com/us

Mexico, Monterrey NL
www.gfms.com/us

Brazil, São Paulo
www.gfms.com/br

Asia

China
Beijing, Shanghai,
Chengdu, Dongguan,
Hong Kong, Changzhou
www.gfms.com/cn

India, Bangalore
www.gfms.com/sg

Japan
Tokyo, Yokohama
www.gfms.com/jp

Korea, Seoul
www.gfms.com/kr

Malaysia, Petaling Jaya
www.gfms.com/sg

Singapore, Singapore
www.gfms.com/sg

Taiwan
Taipei, Taichung
www.gfms.com/tw

Vietnam, Hanoi
www.gfms.com/sg

At a glance

We enable our customers to run their businesses efficiently and effectively by offering innovative Milling, EDM, Laser, Additive Manufacturing, Spindle, Tooling and Automation solutions. A comprehensive package of services completes our proposition.

www.gfms.com



© GF Machining Solutions Management SA, 2022
The technical data and illustrations are not binding.
They are not warranted characteristics and are
subject to change.