

Dynafix

- ... allows machining with optimal cutting data
- ... reduces setting-up times
- ... ensures precision and quality
- ... gives access to System 3R's entire product range
- ... is suitable for automatic changing with System 3R's automation program.

Dynafix permits machining with optimal cutting data, without sacrificing accuracy and quality. The easy-to-handle aluminium pallets have reference elements of high-alloy steel with directly measurable Z-references.

Locking mechanism with built-in soft-landing function protects the references and simplifies handling in applications involving heavy workpieces. In addition, automatic air-blast cleaning of the Z-references and peripheral sealing make Dynafix a practical and user-friendly reference system which minimises setting-up times, increases machine capacity and provides a basis for automated production.

Dynafix as the basic means of fixing to the machine table gives unsurpassed flexibility in terms of workpiece size. Using chuck adapters provides access to practically every reference system in System 3R's extensive product range. Rapid, precise pallet changing in sizes from Ø25 mm to 400 x 400 mm in the same basic mounting – manually or automatically.

- + Repetition accuracy – within 0.002 mm
- + Locking force – 60 000 N
- + Fixed index positions – 4x90°
- + Required air pressure, pneumatic chuck – 6±1 bar.

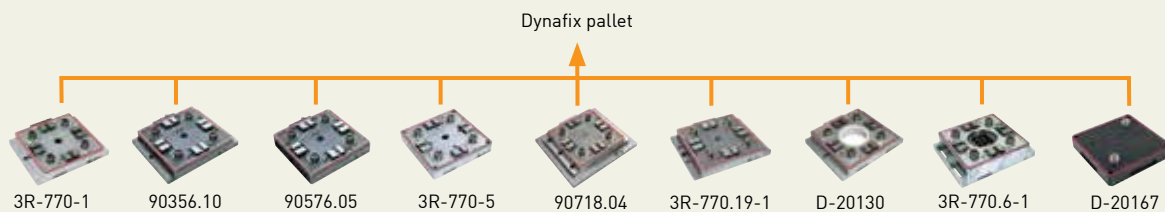
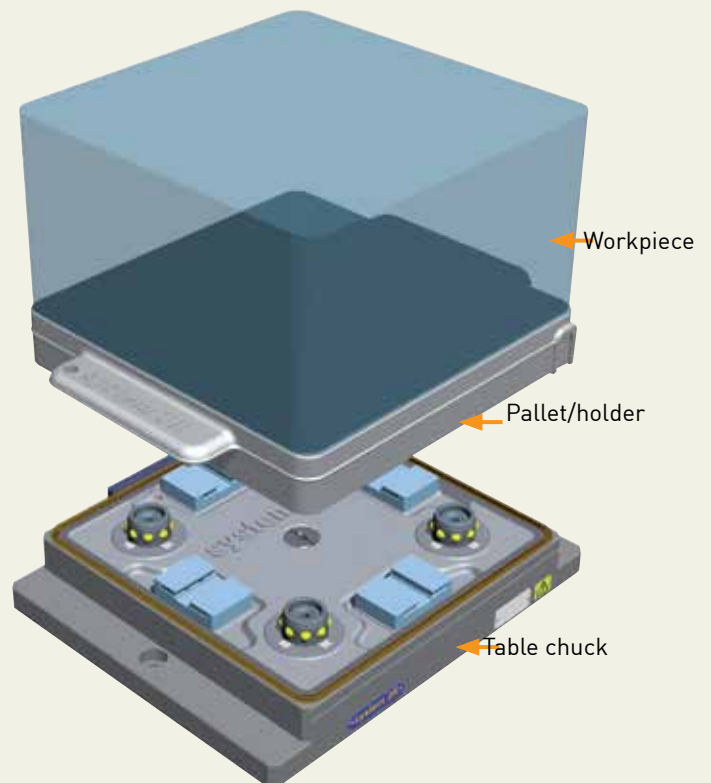

| Chucks | Article number | Feature |
|-----------|----------------|---|
| Pneumatic | 3R-770-1 | |
| Pneumatic | 90356.10 | for chuck adapters, with mounting flange |
| Pneumatic | 90576.05 | for chuck adapters, without mounting flange |
| Pneumatic | 3R-770-5 | for five-axis machines |
| Pneumatic | 90718.04 | vibration-damped |
| Pneumatic | 3R-770.19-1 | 3Refix holes |
| Pneumatic | 3R-770.6-1 | built-in pneumatic Macro chuck |
| Pneumatic | D-20130 | through hole Ø110 mm. |
| Pneumatic | D-20167 | load station |

Dynafix – Chucks

Pneumatic chuck, 3R-770-1

Pneumatic table chuck.

- Required air pressure 6 ± 1 bar
- Fixed index positions $4 \times 90^\circ$
- Recommended actuator 3R-611.4 or 3R-611.2.
- Air-blast cleaning of the Z-references
- Weight 24.5 kg.

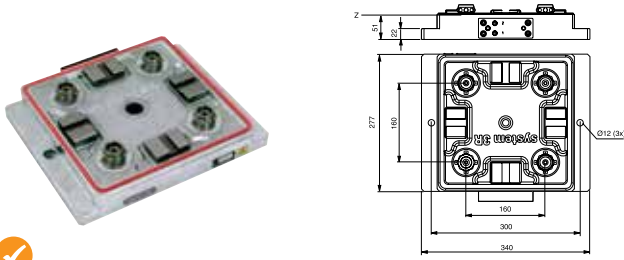

Pneumatic chuck, 3R-770.19-1

Pneumatic table chuck with 3Refix-holes.

- 3Refix $\varnothing 20$ mm
- Required air pressure 6 ± 1 bar
- Fixed index positions $4 \times 90^\circ$
- Recommended actuator 3R-611.4 or 3R-611.2
- Air-blast cleaning of the Z-references
- Weight 24.5 kg.

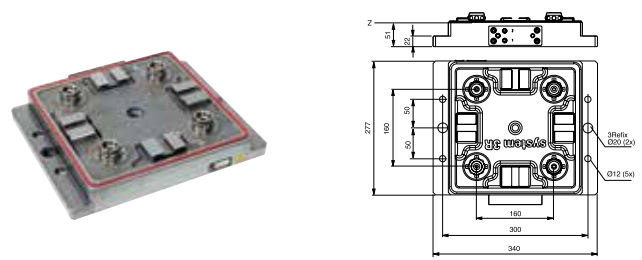

Pneumatic chuck

Pneumatic chucks with extra connections for automatic chuck adapters.

Note: Requires two control units.

- Required air pressure 6 ± 1 bar
- Fixed index positions $4 \times 90^\circ$
- Air-blast cleaning of the Z-references.

90356.10

With fixing lugs.

- Weight 24.5 kg.



90576.05

Without fixing lugs.

- Weight 23.5 kg.



Pneumatic chuck, 3R-770-5

Pneumatic table chuck for applications in five-axis machines. Air connection from below.

- Required air pressure 6 ± 1 bar
- Fixed index positions $4 \times 90^\circ$
- Air-blast cleaning of the Z-references
- Weight 23.5 kg.

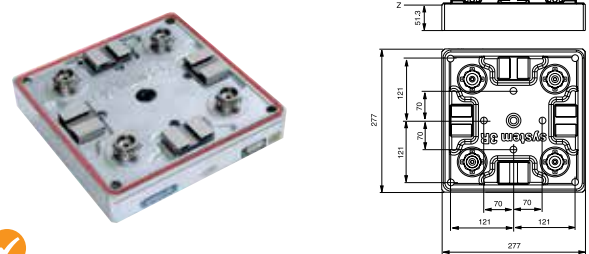

Pneumatic chuck, VDP, 90718.04

Pneumatic vibration-damped chuck.

- Required air pressure 6 ± 1 bar
- Fixed index positions $4 \times 90^\circ$
- Air-blast cleaning of the Z-references.



Pneumatic chuck, D-20130

Pneumatic chuck with through holes $\varnothing 110$ mm.

- Required air pressure 6 ± 1 bar
- Fixed index positions $4 \times 90^\circ$
- Air-blast cleaning of the Z-references
- Weight 22 kg.



Dynafix – Chucks



Pneumatic chuck, 3R-770.6-1

Pneumatic chuck with integrated Macro chuck.
For CMM machines.

- Required air pressure 6 ± 1 bar
- Fixed index positions $4 \times 90^\circ$
- Air-blast cleaning of the Z-references
- Weight 32 kg.



Pneumatic dummy chuck, D-20167

To use as a load station for pallets with workpieces.

- Rust resistant
- Prepared for sensor 05-7041
- Clamping force 5 000 N
- Max load weight 250 kg
- Weight 11 kg.

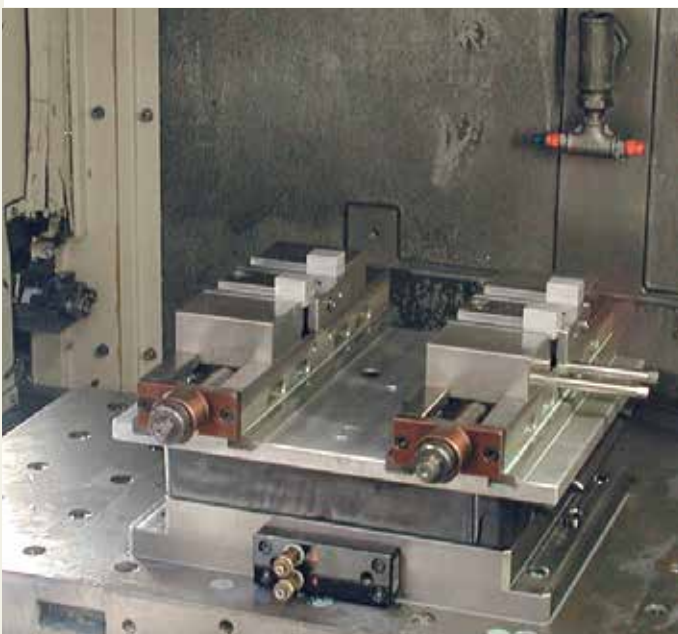

Dynafix – Chuck adapters

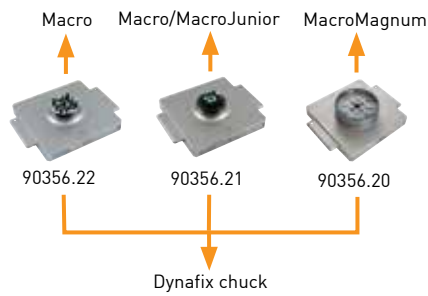

| Chuck adapters | Article number | Feature |
|----------------|----------------|-----------------------|
| Pneumatic | 90356.22 | Dynafix ► Macro |
| Pneumatic | 90356.21 | Dynafix ► MacroCombi |
| Pneumatic | 90356.20 | Dynafix ► MacroMagnum |

Pneumatic chuck adapter, Dynafix-Macro, 90356.22

Chuck adapter with built-in pneumatic Macro chuck for mounting in 90356.10 or 90576.05.

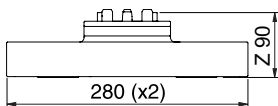

Pneumatic chuck adapter, Dynafix-MacroCombi, 90356.21

Chuck adapter with built-in pneumatic MacroCombi chuck for mounting in 90356.10 or 90576.05.

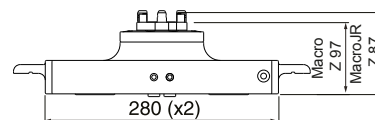

Pneumatic chuck adapter, Dynafix-MacroMagnum, 90356.20

Chuck adapter with built-in pneumatic MacroMagnum chuck for mounting in 90356.10 or 90576.05.

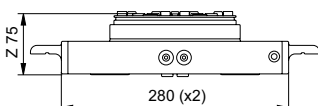

Dynafix – Pallets

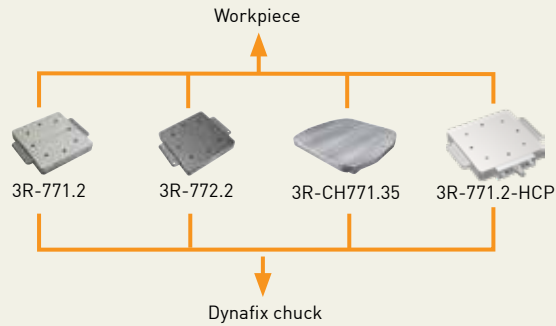

| Pallets 280x280 mm | Article number | Feature |
|--------------------|----------------|------------------------|
| Aluminium | 3R-771.2 | milled |
| Aluminium | 3R-772.2 | ground |
| Aluminium | 3R-CH771.35 | |
| Aluminium | 3R-771.2-HCP | milled, HCP robot grip |

Pallet 280x280 mm, 3R-771.2

Milled aluminium pallet.

- Adapted for automatic changing
- Ready for code carrier
- Flatness 0.04 mm
- Thickness tolerance +0.05/-0 mm
- Weight 6 kg.

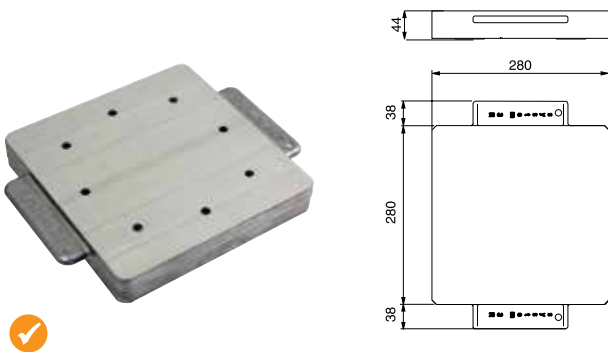

Pallet 280x280 mm, 3R-772.2

Ground aluminium pallet.

- Adapted for automatic changing
- Ready for code carrier
- Flatness 0.005 mm
- Thickness tolerance -0.1/-0.14 mm
- Weight 6 kg.

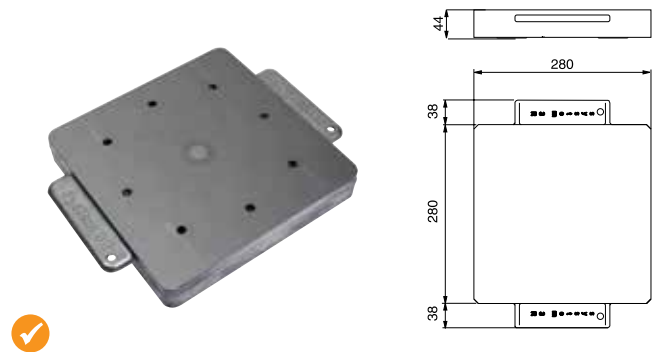

Pallet with HCP robot grip, 3R-771.2-HCP

Milled pallet with HCP robot grip mounted on pallet side.

- Prepared for through holes (sealed at delivery)
- Adapted for automatic changing.
- Load weight 150 kg.
- Weight 6.5 kg.



Pallet 350x350 mm, 3R-CH771.35

Aluminium pallet.

- Adapted for automatic changing.
- Ready for code carrier
- Weight 12.1 kg.

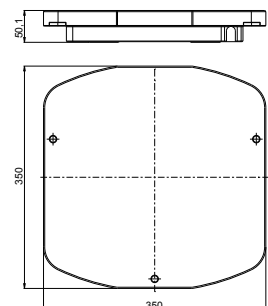

Dynafix – Accessories

Reference elements, 3R-771.7

Reference kit for users who want to make their own pallets or fixtures.



Master pallet, 3R-776.1-2

For alignment of the Dynafix references. With ground reference rulers, hole and surface.

- Adapted for automatic changing
- Ready for code carrier
- Weight 8 kg.



Clamping force meter kit, 3R-SSP115-BASE

For both pneumatic and manual chucks. This stand alone unit in combination with individual drawbars or drawbar kits, able to cover MacroJunior, Macro, MacroMagnum and Dynafix.

Note: Require drawbars with bayonet interface similar to 3R-605.1.

- Add-on kit for use in Dynafix, 3R-SSP115-DYN
- Operating temp. +10 to +40° C
- Gauge size Ø90x47 mm
- Working range 1-22 kN
- Deviation ± 0.1 kN.
- Weight:
Display 0.34 kg.
Gauge 1.3 kg.



Add-on kit, 3R-SSP115-DYN

Add-on kit for 3R-SSP115-BASE

